

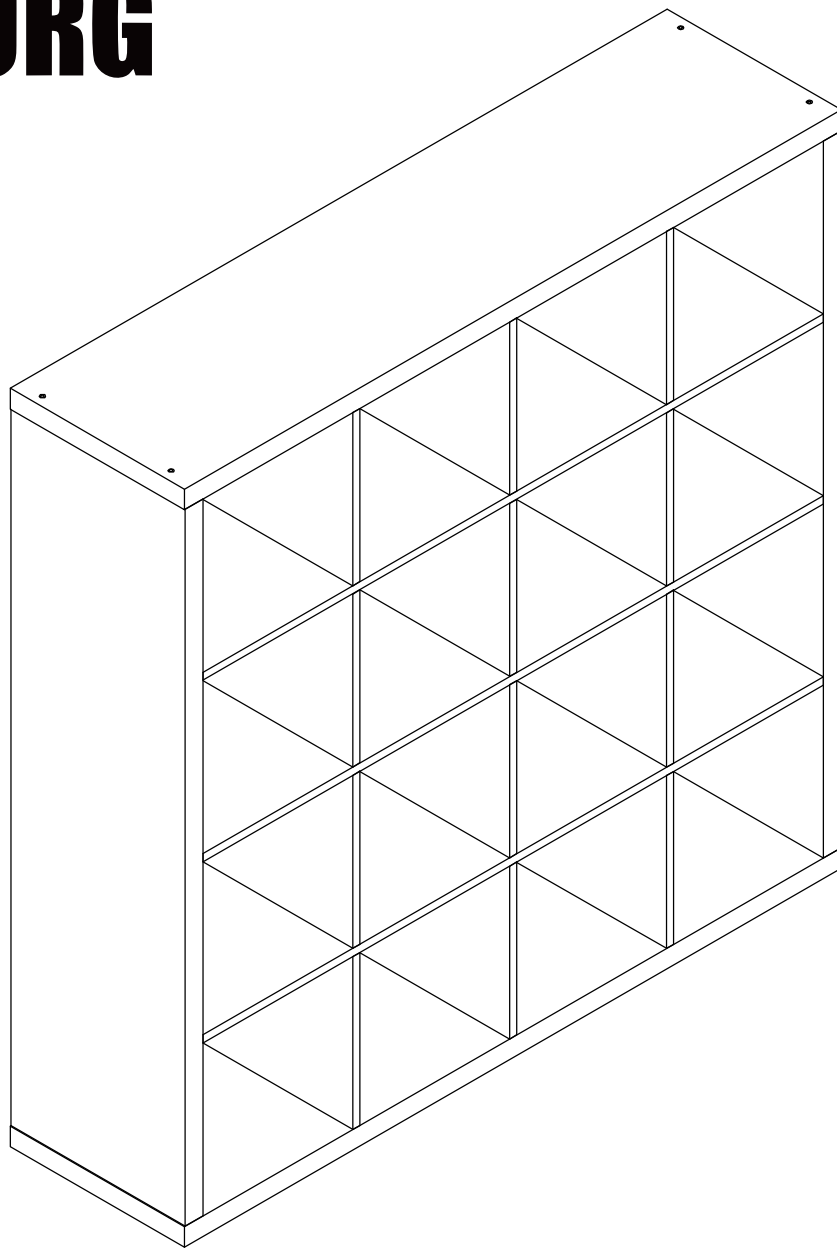





BÜRG



NO.	QTY.	LINEDRAWING
A	8	
B	36	 Φ 6x60
C	48	 Φ 6x35
D	4	
E	7	
F	1	



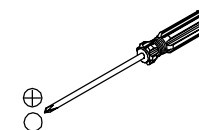
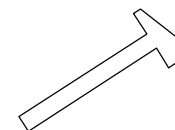
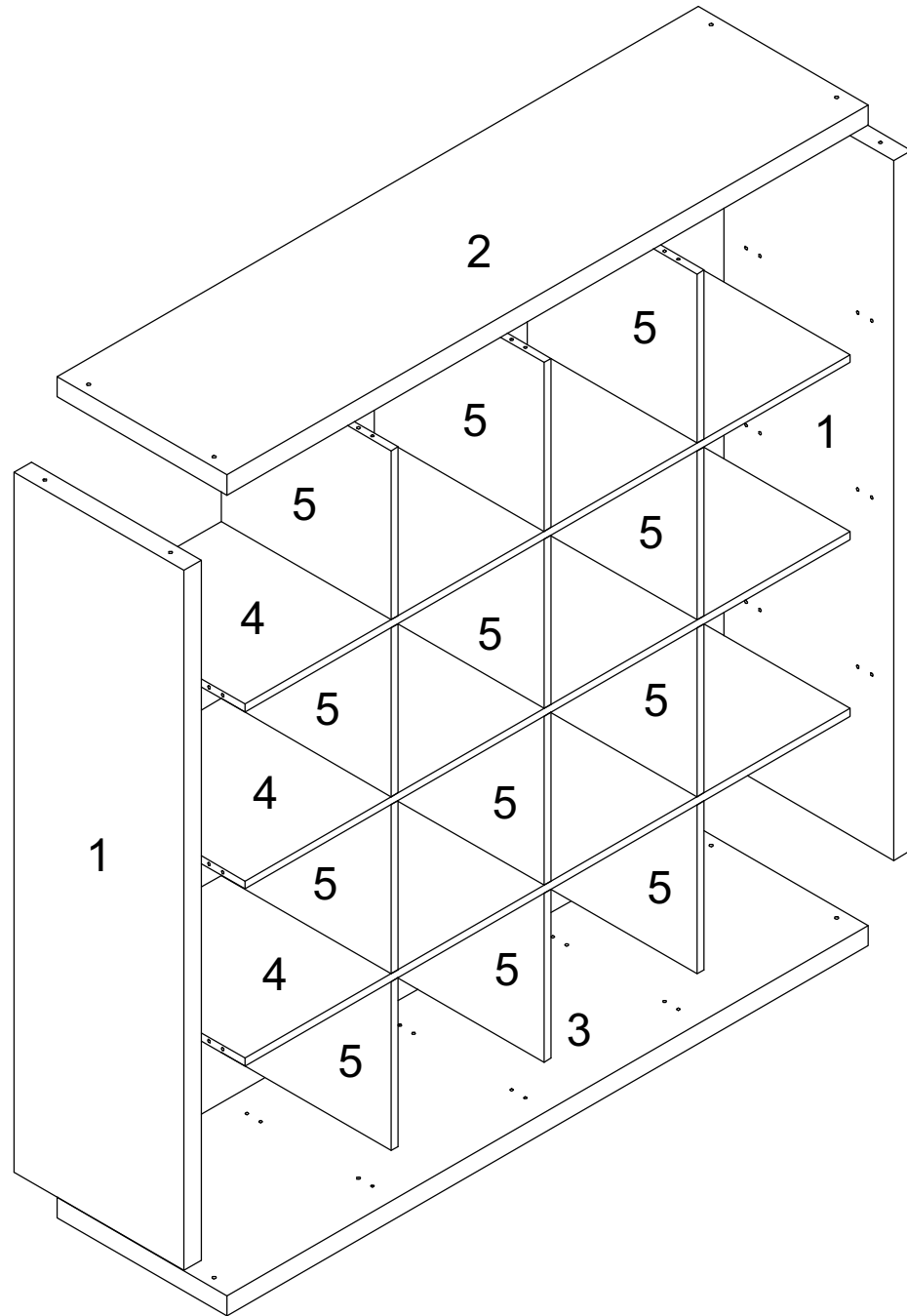

NO.	QTY.	LINEDRAWING
1	2	
2	1	
3	1	
4	3	
5	12	

1

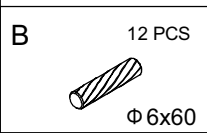
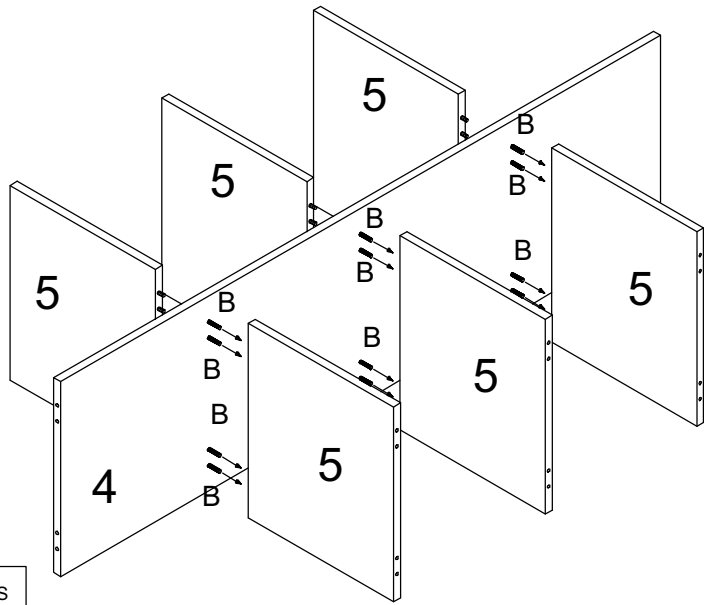

2

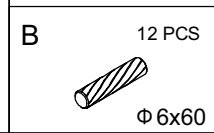
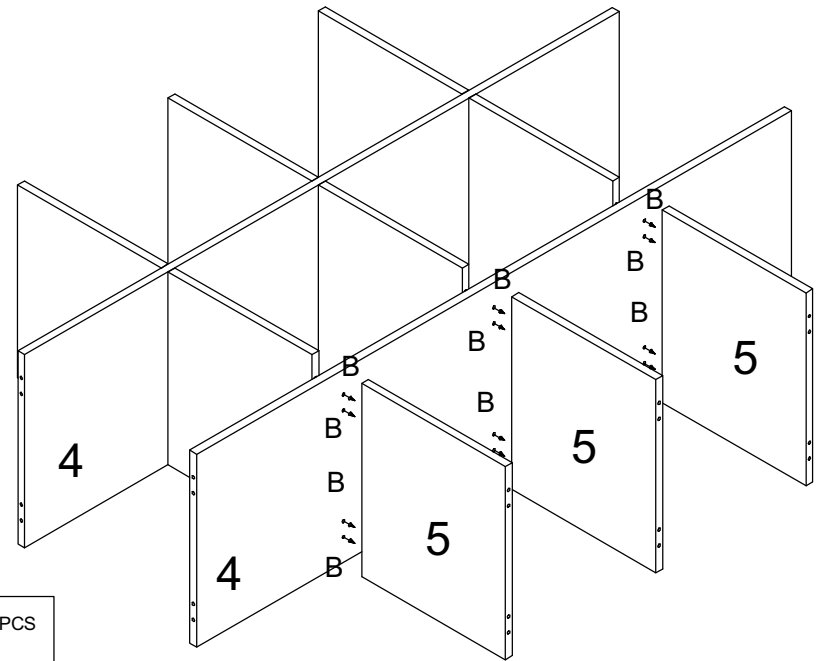

3

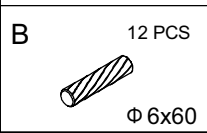
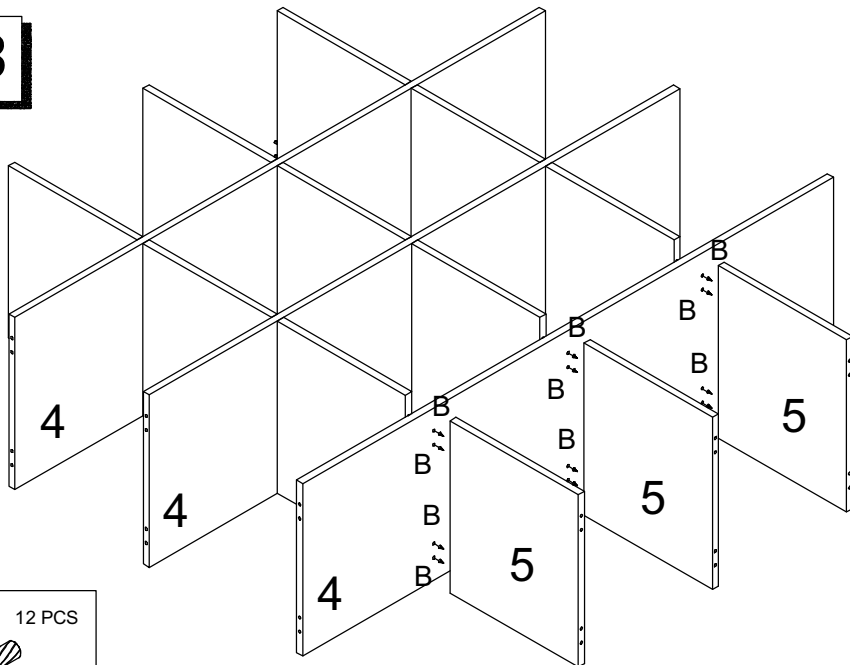

4

